

VP54021



Miscelatore monocomando vasca a pavimento, portata 20 l/min. Aeratore 24x1 con deviatore automatico. Doccetta rotonda 1 getto in abs, portata 14 l/min, con supporto fisso in metallo. Flessibile Cromoflex in plastica effetto metallo, lunghezza 150 cm, con sistema antitorsione. Da abbinare solo con articolo PI44010.

Floor bath single lever mixer, 20 l/min flow rate. 24x1 aerator with automatic diverter. 1 jet round abs handshower, 14 l/min flow rate, with metal fixed support. Metal effect Cromoflex plastic flexible, length 150 cm, with anti-torsion system. To be matched only with article PI44010.

CARATTERISTICHE FEATURES



CERTIFICAZIONI PRODOTTO PRODUCT APPROVALS

L'articolo può disporre di alcune di queste certificazioni. The article may have some of these approvals.

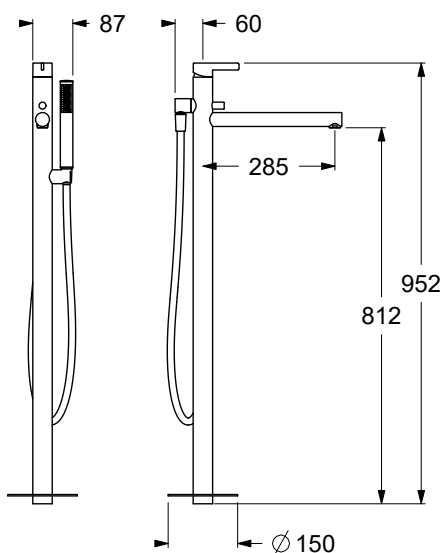

IMBALLI E RICICLABILITÀ PACKAGING AND RECYCLING

SCATOLA BOX	VOLUME VOLUME	TARA TARE	PESO LORDO GROSS WEIGHT
24 x 50 x 102 cm	0,122 m ³	1,05 kg	5,01 kg
COLLO MC	VOLUME VOLUME	TARA TARE	N° SCATOLE PER COLLO N° BOXES FOR MC
24 x 50 x 102 cm	0,122 m ³	0,122 kg	1
PLASTICA PLASTIC	CARTA PAPER	PALLET PALLET	N° COLLI PER PALLET N° MC FOR PALLET
0,002 kg	1,172 kg	9,6 kg	4

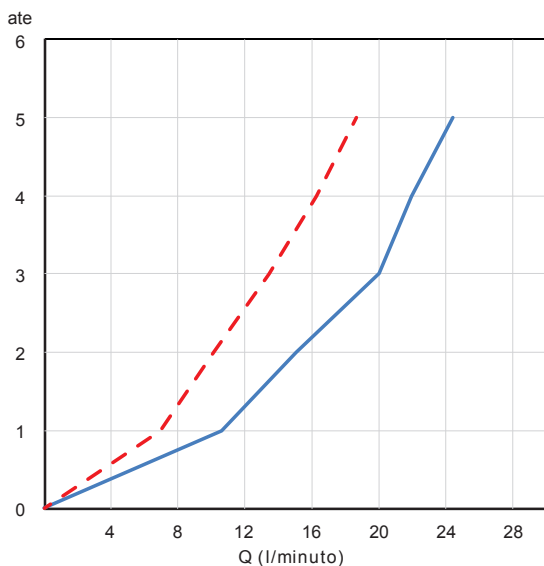

DIAGRAMMA DI PORTATA FLOW RATE DIAGRAM

Test eseguito secondo le norme europee EN 817 - EN 200. Portata calcolata con l'impiego di aeratori certificati.

Test carried out according to the European standards EN 817 - EN 200. Flow rate calculated by the application of certified aerators.

Doccia / Shower	- - - - -				
ate	1	2	3	4	5
Q (l/min)	7,5	10,5	12,9	16,2	18,7
Vasca / Bath	—————				
ate	1	2	3	4	5
Q (l/min)	11,0	15,4	20,0	21,7	24,2