

GZ06810



Rubinetto a 3 fori per lavabo, aeratore 24x1. Vitoni ceramici, portata 12 l/min. Comando scarico a pressione 1"¼ in metallo con vite di bloccaggio, flex di alimentazione softpex 3/8". Sistema di aggancio rapido per il collegamento dell'acqua.

3-hole washbasin tap, 24x1 aerator. Ceramic valves, 12 l/min flow rate. Control for 1"¼ push-plug waste of metal with blocking screw, 3/8" connection flexible hoses of softpex. Quick coupling system for water connection.

CARATTERISTICHE FEATURES



CERTIFICAZIONI PRODOTTO PRODUCT APPROVALS

L'articolo può disporre di alcune di queste certificazioni. The article may have some of these approvals.

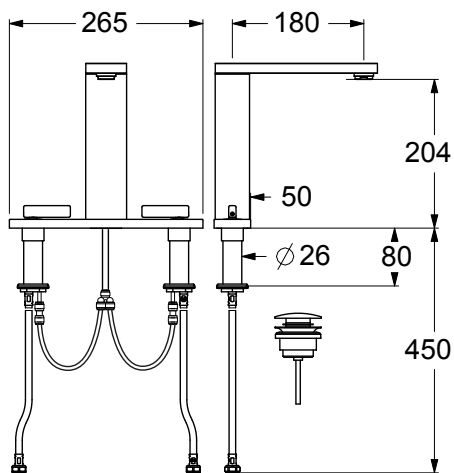

IMBALLI E RICICLABILITÀ PACKAGING AND RECYCLING

SCATOLA BOX	VOLUME VOLUME	TARA TARE	PESO LORDO GROSS WEIGHT
11,3 x 33 x 45,7 cm	0,017 m ³	0,37 kg	4,2 kg
COLLO MC	VOLUME VOLUME	TARA TARE	N° SCATOLE PER COLLO N° BOXES FOR MC
40 x 71 x 51 cm	0,145 m ³	1,6 kg	6
PLASTICA PLASTIC	CARTA PAPER	PALLET PALLET	N° COLLI PER PALLET N° MC FOR PALLET
0,312 kg	0,64 kg	9 kg	6

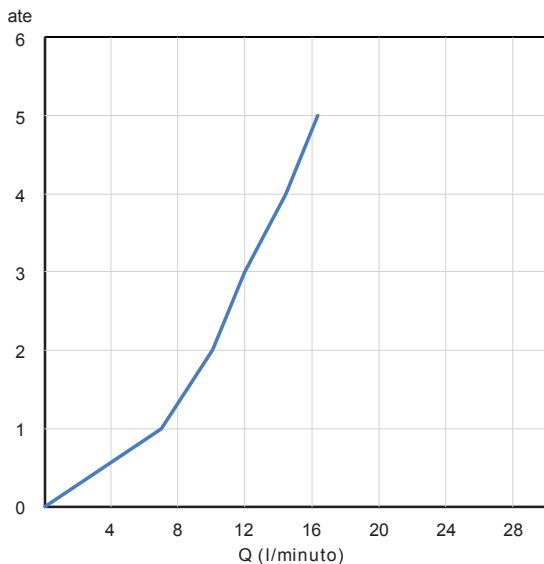

DIAGRAMMA DI PORTATA FLOW RATE DIAGRAM

Test eseguito secondo le norme europee EN 817 - EN 200. Portata calcolata con l'impiego di aeratori certificati.

Test carried out according to the European standards EN 817 - EN 200. Flow rate calculated by the application of certified aerators.

ate	1	2	3	4	5
Q (l/min)	7,1	10,2	12,0	14,4	16,1