

GX00020

Miscelatore monocomando per lavabo, aeratore 24x1. Cartuccia ceramica, portata 9 l/min. Comando scarico a pressione 1"¼ in metallo con vite di bloccaggio, flex di alimentazione softpex 3/8". Fissaggio con sistema rapido.

Single lever washbasin mixer, 24x1 aerator. Ceramic cartridge, 9 l/min flow rate. Control for 1"¼ push-plug waste of metal with blocking screw, 3/8" connection flexible hoses of softpex. Fixing with rapid system.



CARATTERISTICHE FEATURES



CERTIFICAZIONI PRODOTTO PRODUCT APPROVALS

L'articolo può disporre di alcune di queste certificazioni. The article may have some of these approvals.

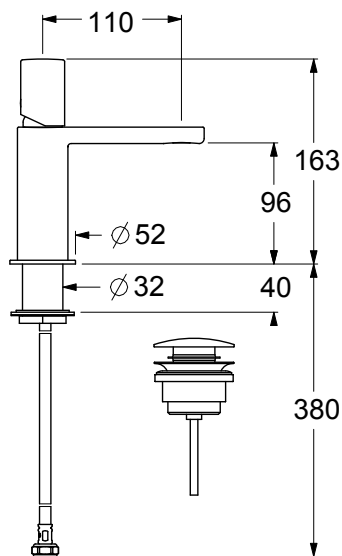

FORO UTILE HOLE WIDTH Ø35

IMBALLI E RICICLABILITÀ PACKAGING AND RECYCLING

SCATOLA BOX	VOLUME VOLUME	TARA TARE	PESO LORDO GROSS WEIGHT
7 x 21,2 x 39,5 cm	0,006 m³	0,25 kg	1,61 kg
COLLO MC	VOLUME VOLUME	TARA TARE	N° SCATOLE PER COLLO N° BOXES FOR MC
38 x 40 x 40 cm	0,061 m³	0,9 kg	8
PLASTICA PLASTIC	CARTA PAPER	PALLET PALLET	N° COLLI PER PALLET N° MC FOR PALLET
0,02 kg	0,3625 kg	9 kg	18

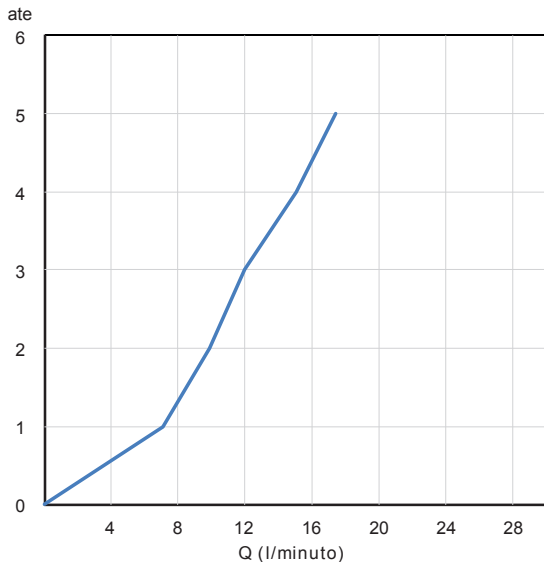

DIAGRAMMA DI PORTATA FLOW RATE DIAGRAM

Test eseguito secondo le norme europee EN 817 - EN 200. Portata calcolata con l'impiego di aeratori certificati.

Test carried out according to the European standards EN 817 - EN 200. Flow rate calculated by the application of certified aerators.

ate	1	2	3	4	5
Q (l/min)	7,2	10,0	12,1	15,6	17,0