

AP60040

Miscelatore monocomando per lavello, bocca girevole, aeratore 22x1, cartuccia ceramica per acqua domestica portata 12 l/min. Vitone ceramico 45° in ecobrass per acqua naturale, portata 5 l/min. Flex di alimentazione softpex 3/8", fissaggio a 3 viti, tubo LLDPE alimentare con aggancio rapido, valvola di intercettazione. Completo di sistema di microfiltrazione con attacco parete a 2 viti.

Single lever sink mixer, swivel spout, 22x1 aerator, ceramic cartridge for domestic water 12 l/min flow rate. 45° ceramic ecobrass valve for still water, 5 l/min flow rate. 3/8" connection flexible hoses of softpex, assembling support with 3 screws, LLDPE food pipe with quick connection, interception valve. Complete with microfiltration system with 2 screws wall-mounted attack.

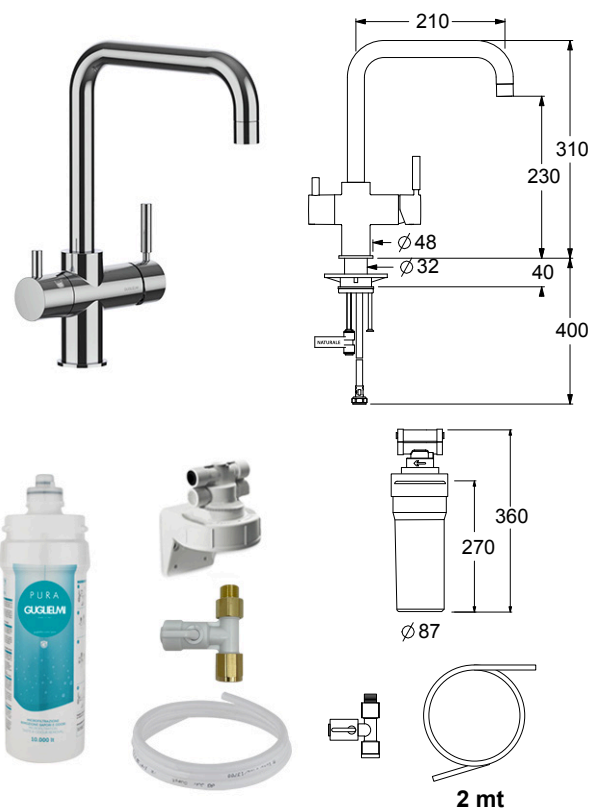

CARATTERISTICHE FEATURES



CERTIFICAZIONI PRODOTTO PRODUCT APPROVALS

L'articolo può disporre di alcune di queste certificazioni. The article may have some of these approvals.



IMBALLI E RICICLABILITÀ PACKAGING AND RECYCLING

SCATOLA BOX	VOLUME VOLUME	TARA TARE	PESO LORDO GROSS WEIGHT
11 x 36,5 x 78 cm	0,031 m ³	0,95 kg	4,19 kg
COLLO MC	VOLUME VOLUME	TARA TARE	N° SCATOLE PER COLLO N° BOXES FOR MC
38 x 80 x 40 cm	0,122 m ³	1,2 kg	3
PLASTICA PLASTIC	CARTA PAPER	PALLET PALLET	N° COLLI PER PALLET N° MC FOR PALLET
0,552 kg	1,35 kg	9,6 kg	9

FORO UTILE HOLE WIDTH Ø35

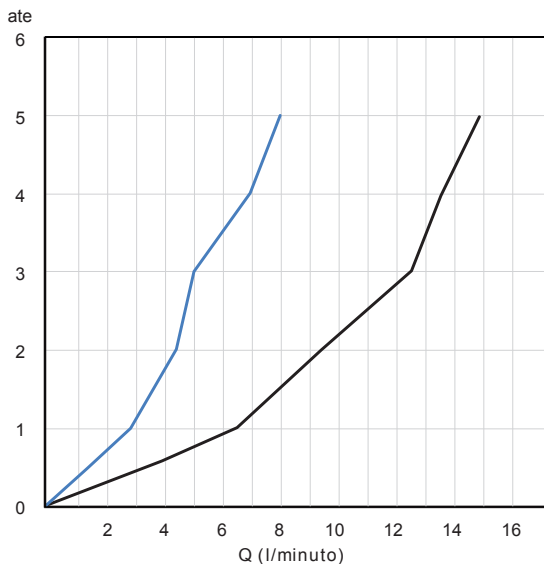

DIAGRAMMA DI PORTATA FLOW RATE DIAGRAM

Test eseguito secondo le norme europee EN 817 - EN 200. Portata calcolata con l'impiego di aeratori certificati.

Test carried out according to the European standards EN 817 - EN 200. Flow rate calculated by the application of certified aerators.

ACQUA DOMESTICA DOMESTIC WATER					ACQUA MICROFILTRATA MICROFILTERED WATER						
Acqua miscelata Mixed water	ate				Acqua naturale Still water	ate					
ate	1	2	3	4	5	ate	1	2	3	4	5
Q (l/min)	6,7	9,4	12,6	13,5	14,9	Q (l/min)	2,9	4,4	5,0	7,0	8,0