

VT40920

Miscelatore termostatico per vasca esterno con fermo di sicurezza a 38°. Aeratore 28x1 con deviatore automatico. Cartuccia termostatica, portata 20 l/min. Raccordo 1/2".

Thermostatic external single lever bath mixer with safety lock 38°. 28x1 aerator with automatic diverter. Thermostatic cartridge, 20 l/min flow rate. 1/2" flexible connection.



CARATTERISTICHE FEATURES



CERTIFICAZIONI PRODOTTO PRODUCT APPROVALS

L'articolo può disporre di alcune di queste certificazioni. The article may have some of these approvals.

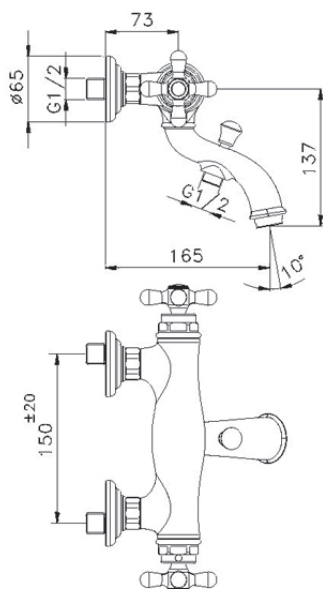

IMBALLI E RICICLABILITÀ PACKAGING AND RECYCLING

SCATOLA BOX	VOLUME VOLUME	TARA TARE	PESO LORDO GROSS WEIGHT
13,4 x 22,4 x 30,5 cm	0,009 m³	0,28 kg	1,58 kg
COLLO MC	VOLUME VOLUME	TARA TARE	N° SCATOLE PER COLLO N° BOXES FOR MC
38 x 40 x 40 cm	0,061 m³	0,88 kg	4
PLASTICA PLASTIC	CARTA PAPER	PALLET PALLET	N° COLLI PER PALLET N° MC FOR PALLET
0,002 kg	0,5 kg	9,6 kg	18

DIAGRAMMA DI PORTATA FLOW RATE DIAGRAM

Test eseguito secondo le norme europee UNI EN 1111. Portata calcolata con l'impiego di aeratori certificati.

Test carried out according to the European standards UNI EN 1111. Flow rate calculated by the application of certified aerators.

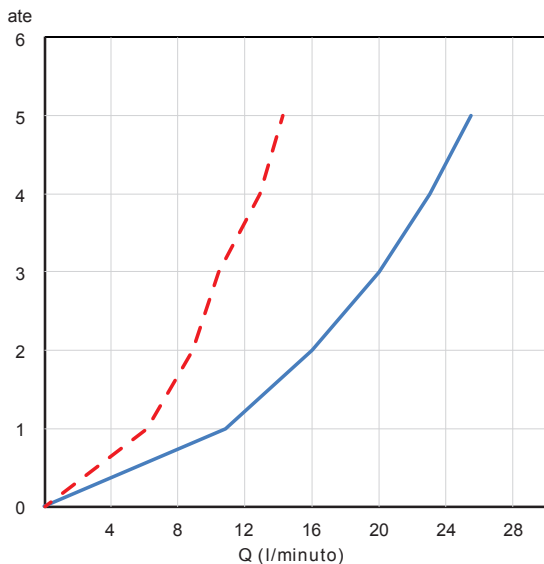

Doccia / Shower	-----				
ate	1	2	3	4	5
Q (l/min)	6,1	8,6	10,8	12,6	14,0
Vasca / Bath	—————				
ate	1	2	3	4	5
Q (l/min)	11,1	16,0	20,1	23,1	25,8